

USING A STATISTICAL ENERGY ANALYSIS APPROACH FOR A TILT-ROTOR AIRCRAFT: A COMPARATIVE STUDY WITH ATPA RESULTS

Shahin Sohrabi^{1*} Ester Cierco¹ Amadeu Segura¹
Alessandro Perazzolo² Giuseppe Bizarro² Pere Vicenç Rodríguez¹
¹ Ingeniería para el Control del Ruido (ICR), Berruguete Street, 52, Barcelona
² Leonardo Company, Giovanni Agusta Street, 520, Cascina Costa, Varesa, Italy

ABSTRACT

In industrial projects involving complex structures, the numerical simulation may help to reduce the time and cost of the project. In this study, Virtual Statistical Energy Analysis (VSEA) proposed by Actran is used to simulate the vibroacoustic behavior of a tilt-rotor aircraft and to predict the sound pressure level inside the cavity of the aircraft. To this end, experimental measurements are performed to provide several inputs for the simulation. The internal cabin is divided into subsystems following the Advanced Transfer Path Analysis (ATPA) approach. The frequency-dependent damping loss factors of the panels are calculated through the decay rate method from impact tests experimental data. Moreover, the operational forces applied to the system are obtained by measuring the accelerance FRFs and the acceleration in operative conditions. An extrapolation method is used to obtain results in a mid-high frequency range. The resulting sound pressure level inside the cavity of the aircraft is compared with the structure-borne noise calculated by ATPA in a range of frequency from 900 to 4000 Hz.

Keywords: *Statistical energy analysis, Advanced transfer path analysis, Frequency response function, Interior sound pressure*

*Corresponding author: shahinsohrabi@icrsl.com.

Copyright: ©2023 First author et al. This is an open-access article distributed under the terms of the Creative Commons Attribution 3.0 Unported License, which permits unrestricted use, distribution, and reproduction in any medium, provided the original author and source are credited.

1. INTRODUCTION

A vibroacoustic analysis is a necessary step for the design of aircraft. A simulation model is essential to decrease development cycles, lower design expenses, and evaluate the influence of component performance on acoustic comfort.

Interior noise plays an important role in the design of aerospace structures. It may negatively affect the onboard electronic equipment and cause passenger discomfort. Various sources contribute to creating interior noise, such as engine noise, aerodynamic flow over aircraft, etcetera. A mature model may predict the aircraft's interior noise level and improve the model's acoustic performance.

The vibroacoustic behaviour of complex structures at high frequencies is influenced by many factors such as boundary conditions, geometric complexity, and coupling between structural and acoustic domains. These factors make it computationally expensive to calculate the mode shapes of the structure at high frequencies.

Although there is no certain model that is applicable to a wide frequency range of noise, in the aerospace industry, energy-based approaches are increasingly used to study the transmission of vibration through aircraft structures in the mid to high-frequency range [1, 2]. Statistical Energy Analysis (SEA) is a well-known energy-based method that can determine a structure's dynamic response and vibroacoustic behaviour [3, 4]. This method is more frequent for complex structures such as airplanes and automotive vehicles.

There are alternative approaches to estimating the vibration contribution of complex systems, which rely on the utilization of a transmissibility matrix [5-7]. These

approaches involve the creation of a matrix that describes the relationship between input and output vibrations.

Advanced Transfer Path Analysis (ATPA) is another technique used to identify and quantify the transfer paths of vibration and noise within a complex mechanical system. This method is used in the design and development of complex mechanical systems to improve their acoustic and vibration performance [8-10]. By identifying and quantifying the contributions of individual transfer paths, it becomes possible to optimize the noise and vibration behaviour of the system.

In this study, the interior noise of the tilterotor at high frequencies has been modelled with the extended solution of the SEA module of Actran software and also experimentally measured by the ATPA technique. The results obtained by these two methods are compared.

For the VSEA method, the operational forces and the damping loss factors of the panels are computed experimentally based on the matrix inversion procedure and decay rate method, respectively. The following sections describe the methodology used for ATPA and SEA methods and the required information needed for the SEA model in Actran.

2. METHODOLOGY

2.1 Advanced transfer path analysis (ATPA)

Understanding how vibration and noise are transferred and distributed is crucial when analysing a vibroacoustic system. ATPA is a method based on the theory of transfer matrices. The details of this method are presented in [9]. ATPA characterizes the topology of the mechanical system to find out the vibroacoustic paths and the contributions of the system's components, called subsystems, to the noise at any receiver. This method works based on the coefficients of the global transfer matrix T^G which are defined as [8]

$$T_{ij}^G = \frac{x_j}{x_i} \quad (1)$$

Where x_j is the signal at node j whilst an excitation is applied at node i . Typically, x_j is an acceleration, a rotation acceleration, or a pressure.

The global transfer matrix is related to the contributions of subsystems. On the other hand, the direct transfer matrix T^D is another coefficient that is used to characterize paths. The

coefficient T_{ij}^D has information about the path between the nodes i and j and is defined as

$$T_{ij}^D = \frac{x_j}{x_i} \quad (2)$$

with all the nodes other than i and j blocked. The direct transfer matrix can also be defined from any of the nodes to an external target point T where some output of interest is defined and controlled.

$$T_{iT}^D = \frac{p_T}{x_i} \quad (3)$$

In this case, p_T can be the pressure at the target point T when excitation is applied. T_{iT}^D is calculated as the relation between the pressure in the target T and the excitation at node i , having all the nodes $j \neq i$ blocked. The total pressure at the target point T is defined as

$$p_T = \sum_{i=1}^N x_i T_{iT}^D + p_T^e \quad (4)$$

where p_T is a signal in the target, x_i is the measured signal in subsystem i (i.e. acceleration of a vibrating panel), T_{iT}^D is the direct transfer function between subsystem i and the target and N is the number of subsystems in which the mechanical system has been divided. In Eqn. (4), p_T^e is the direct field of the signal that arrives at T due to an external excitation when all the N nodes are blocked.

In addition, a relationship between the global transfer defined in Eqn. (1) and the direct transfer defined in Eqn. (3) can be obtained.

$$\sum_{j=1}^N T_{ij}^G T_{jT}^D = T_{iT}^G \quad \text{for } i = 1, 2, \dots, N \quad (5)$$

The characterization of the paths is then reduced to the mathematical problem of determining the coefficients T_{iT}^D . This can be done, for example, by means of the solution of the linear system of just N equations like Eqn. (5) (for the case of exactly N executions of the experiment).

In the ATPA, there are two types of subsystems including the structural and panel subsystems. The structural subsystems are those that link the vibroacoustic source to panels. Panels refer to the system's components that

surround the target and contribute to the noise perceived at it.

ATPA can synthesize the structure-borne and air-borne noise of the panel subsystems. In this regard, the total contribution from a panel or structural subsystem is defined by Eqn. (6).

$$p_{syn,T}(\omega,t) = \sum_{i=0}^N a_i(\omega,t)T_{iT}^D(\omega) = \sum_{i=0}^N p_i(\omega,t) \quad (6)$$

where i corresponds to a panel or a structural subsystem, $a_i(\omega,t)$ is the acceleration in subsystem i and $T_{iT}^D(\omega)$ is the direct transfer function from subsystem i to target T . In this equation, $p_i(\omega,t)$ is the noise contribution of subsystem i at the target location T .

Structure to panel contribution obtains through a 2-step calculation:

$$a_{syn,i}(\omega,t) = \sum_{j=0}^M a_j(\omega,t)T_{ji}^D(\omega) \quad (7)$$

and

$$p_{struct,i}(\omega,t) = a_{syn,i}(\omega,t)T_{iT}^D(\omega) \quad (8)$$

where i corresponds to a panel subsystem, j corresponds to a structural subsystem $a_{syn,i}(\omega,t)$, is the synthesized acceleration in panel i due to structural excitation, and $p_{struct,i}$ is the synthesized pressure in target T due to structural excitation of the panel. This corresponds to the structure-borne noise contribution of the panel.

The air-borne contribution of each panel is calculated as the subtraction of the total panel contribution and the structural panel contribution:

$$p_{air,i}^2(\omega,t) = p_i^2(\omega,t) - p_{struct,i}^2(\omega,t) \quad (9)$$

2.2 Statistical energy analysis (SEA)

Statistical Energy Analysis (SEA) is a well-known method to analyse the flow of acoustic and vibration energy in a complex structure. SEA is particularly useful for predicting the noise and vibration behaviour of structures with many degrees of freedom and multiple energy pathways at mid and high frequencies. It has a wide range of applications in different industries, including automobiles, aircraft, buildings, and ships. This method involves dividing a complex system into a series of subsystems or components.

Each component is then modelled as a separate entity, with its own set of properties such as mass, stiffness, and damping. The interactions between components are represented by energy flow paths, which are modelled as spring-mass-damper systems. These paths are used to predict the energy transfer between the components and the resulting response of the entire system.

In this study, a fuselage section of a tilt-rotor aircraft has been modelled by using a SEA approach. The numerical model is provided by the use of the commercial software ACTRAN, within the VSEA module. An example of a SEA model using the software ACTRAN can be seen in [12]. The objective of this study is to establish a numerical model to evaluate the sound pressure level at high frequencies within the aircraft cabin in airplane operation (AP) mode.

2.2.1 SEA model inputs

The SEA model in ACTRAN includes three inputs. The mesh of geometry, the boundary conditions of the model, and the mechanical properties of subsystems. The following explanations describe these components.

Mesh

In order to create a mesh for the aircraft body structure, a combination of two-dimensional "plate" elements and one-dimensional "beam" elements have been used. The cavity has meshed with 3D elements of type "Tetra-10" by Nastran. The cavity elements size is defined based on the general rule which states that at least 6 nodes should be included in the shortest wavelength of interest to calculate the modes of the system. The mode shapes have been obtained up to 1250 Hz. Considering this value and the sound speed (343 m/s), the maximum element size inside the cavity is considered 0.04 m. Furthermore, the boundaries of the fluid model precisely follow those defined by the structural mesh. During the calculations, all the elements were coupled.

Operational force calculation

In order to define the aircraft boundary conditions of the model, we obtained the operational force applied to the aircraft from experimental measurements.

The force acting on the fuselage during the operation should be considered in the SEA model to predict the interior noise of the cabin. To this end, the operational forces applied to structural linking points from the wings to the fuselage of the tilt-rotor are calculated for the airplane mode of the

aircraft. The forces are computed based on a matrix inversion procedure. For this procedure, the following inputs are required:

- Accelerance (H) frequency response functions (FRFs) at the linking points. This data has been provided by impacting the linking points between the wings and fuselage with an instrumented hammer.

$$H = \frac{a}{f} \quad (10)$$

- Accelerations in operating conditions. These data are measured at the same structural points.

Considering linear equations with the same number of unknowns may lead to strong inaccuracies in the obtained force [13]. In another word, small modifications in the input data may lead to important changes in the obtained results. In these kinds of problems, there are options available to improve the estimation of the forces, including building an over-determined system of equations. This could be achieved by adding extra equations using the information recorded on some of the internal panels of the tilt-rotor when exciting the structural points. Eqn. (11) represents a system of equations for an over-determined system.

$$\begin{bmatrix} \frac{a}{f_1} & \dots & \frac{a_1}{f_n} \\ \vdots & \dots & \vdots \\ \frac{a_n}{f_1} & \dots & \frac{a_n}{f_n} \\ \frac{a_{n+1}}{f_1} & \dots & \frac{a_{n+1}}{f_n} \\ \vdots & \dots & \vdots \\ \frac{a_{n+p}}{f_1} & \dots & \frac{a_{n+p}}{f_n} \end{bmatrix} \begin{bmatrix} f_1 \\ \vdots \\ f_n \end{bmatrix} = \begin{bmatrix} a_1 \\ \vdots \\ a_n \\ a_{n+1} \\ \vdots \\ a_{n+p} \end{bmatrix} \quad (11)$$

where n is the number of structural points and p is the number of panels used to over-determine the system of equations. This equation has been used to calculate the operational forces.

Figure 1 illustrates the operational forces acting on the six linking points between the wings and the fuselage. There are three linking points on each side of the aircraft. These points are shown in Figure 5.

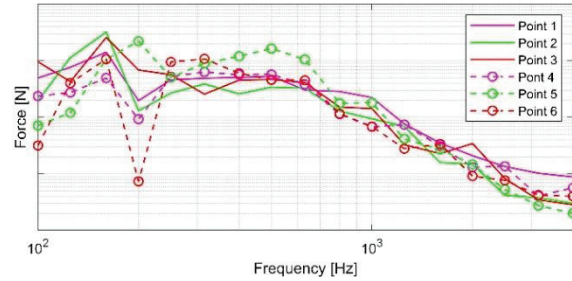

Figure 1. The applied operational force to the structural linking points from the wings

Mechanical properties

The mechanical properties include the damping loss factor of subsystems, the mode shapes of the cavity and structure, and the mass/stiffness matrices.

The mass/stiffness matrices of elements and the mode shapes of the cavity and the structure are obtained from the mesh of the model through the dynamic reduction technique in Nastran.

The damping loss factor (DLF) is a mechanical property that represents the ability of a material or structure to dissipate mechanical energy in the form of vibration. It determines how quickly the system returns to its equilibrium position. The damping loss factor is a crucial parameter to consider when creating a SEA model to obtain accurate results. In this study, the damping loss factors of the panels and the cavity of the aircraft have been calculated based on Decay Rate Method (DRM). This method is based on measuring the response at a mounted accelerometer to a force impulse impacted by a hammer on the panel [14]. The principle of this approach is to identify the time decay needed for an impact response to reduce by 60 dB (T60) compared to the initial peak value (Figure 2). When the dynamic range does not allow for a decay of 60 dB, a lower range of dB might be used. The damping is defined as

$$\eta = \frac{\bar{\alpha}}{\omega} \quad (12)$$

where ω is the angular frequency and the numerator represents the average of $\alpha = \Delta \ln(Acceleration)/T_{60}$ from several impacts.

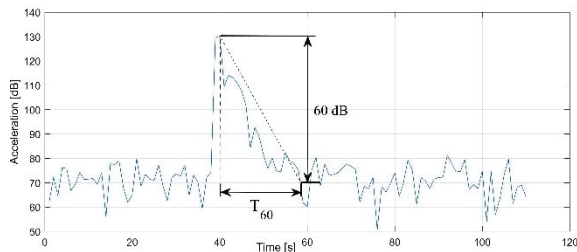

Figure 2. Decay rate method for calculating the damping loss factor.

2.3 Extended solution

Modal density is one of the main parameters in the SEA model and it is a measure of the energy storage capacity of a vibration system. As frequency increases, the modes occur closer and closer together, therefore increasing the modal density. For this reason, at high frequencies, the calculation of the interior sound pressure in the model is a time-demanding procedure.

The aim of this study is to predict the interior noise level of the aircraft at high frequencies with a faster method. To this end, we extracted the mode shapes of the model at low frequencies and used them in an extended solution model of ACTRAN to calculate the noise level at higher frequencies. This solution is based on the extrapolation method.

In this regard, the mode shapes and mass/stiffness matrices have been calculated from 900 Hz to 1250 Hz, with the Nastran Solution 103. These files are imported to the model and the extended solution of Actran (extrapolation) has been employed for the calculation of sound pressure at frequencies up to 4 kHz.

3. SEA MODEL

For the SEA model, the cavity and the structure of the aircraft have been divided into different subsystems. The following sections describe the subsystems defined for the cavity and the structure.

3.1 Cavity Subsystems

The cavity of the aircraft has been divided into six subdivisions. Each subdivision is a subsystem in the model. These subsystems are coupled with each other and with the structural ones.

Figure 3 illustrates two cavity parts of the model where the target microphones in the experimental measurements are located.

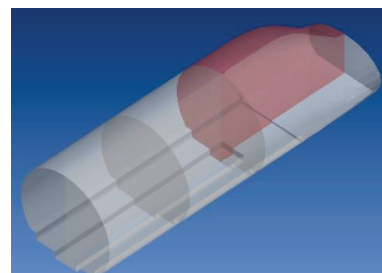

(a)

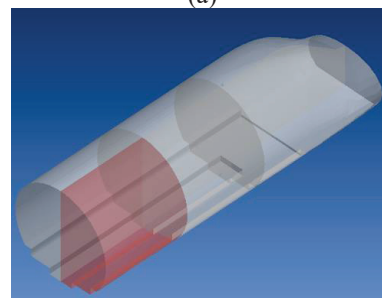

(b)

Figure 3. Cavity subdivisions. (a) Cavity 1, and (b) Cavity 2.

Target 1 and Target 2 are located inside Cavity 1 and Cavity 2 (Figure 3), respectively. The averages of the sound pressures at each cavity are considered as the sound pressures at the target points.

3.2 Structural subsystems

The structure topology of the SEA model includes various structural subsystems. Figure 4 represents only two subsystems of the aircraft model.

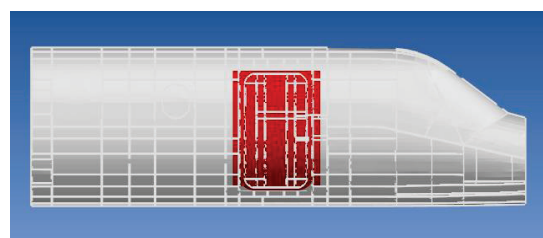

(a)

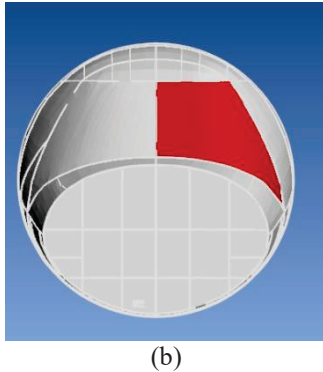

Figure 4. Two subsystems of structure topology. (a) Entrance door, (b) Windshield.

These structural subsystems are the same as the ones considered in the experimental ATPA measurements and they are used in the model to compute the noise contribution.

The operational forces applied to structural linking points from the wings to the fuselage are computed at six points. Figure 5 shows these linking points.

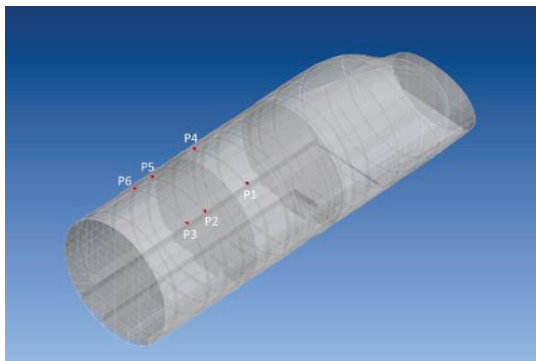

Figure 5. Structural linking points of wings to the fuselage.

4. RESULTS AND DISCUSSIONS

This investigation evaluated the sound pressure levels at high frequencies within the aircraft at two specific target points. Target 1 is located at the position of the pilot seat (Figure 3.a) and Target 2 is placed at the cabin's rare part (Figure 3.b).

Figure 6 shows the sound pressure levels at these two target points synthesized by the ATPA method and the sound pressure level measured by the microphones.

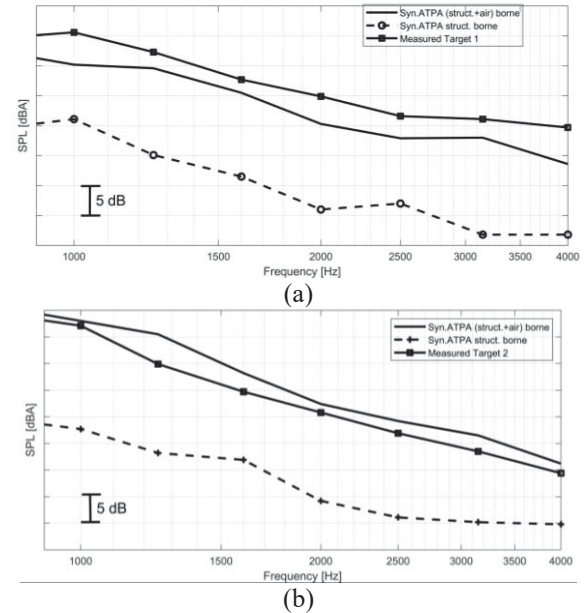

Figure 6. Synthesized sound pressure level calculated by ATPA and measured by microphones at (a) Target 1, and (b) Target 2

Figure 6 shows the synthesized structure and air-borne sound pressures calculated by ATPA are in good agreement with the values measured by the microphones. However, in the SEA model, airborne noise was not considered due to the lack of purely airborne path test (exterior/interior) to characterize the fuselage skin transparency. For this reason, the results of the SEA model should be compared with the structure-borne noise of ATPA. Figure 7 compares the results of the SEA model and ATPA.

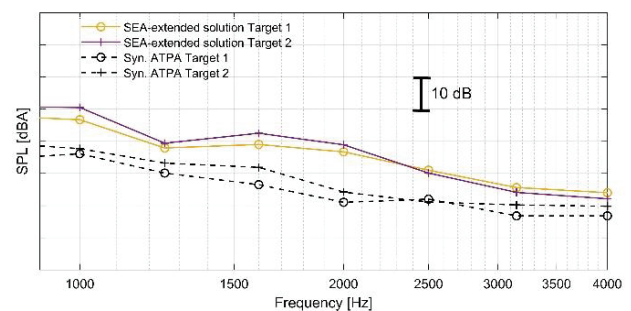

Figure 7. Sound pressure level at Target 1 and Target 2.

As shown in Figure 7, ATPA and SEA methods follow the same trend for noise pressure, and they are in good

agreement at high frequencies. However, at lower frequencies, there are some discrepancies between the results of these methods. These differences can be due to assumptions and simplifications of SEA and ATPA theories that are not able to catch and represent the vibroacoustic behaviour on these frequencies.

Moreover, SEA assumes that the energy transfer between subsystems is diffuse and random, while ATPA focuses on the dominant transfer paths that contribute to sound transmission. Also, the SEA model may not accurately capture the effects of non-uniformities, irregularities, or discontinuities in the structure. Additionally, the SEA results are obtained based on only the mode shapes from 900 Hz and 1250 Hz (interpolation), and for higher frequencies, an extrapolation method is utilized (extended solution).

The accuracy of a SEA model depends on boundary conditions used to describe the interactions between the structure and the cavity. If the boundary conditions are not well-defined or are not representative of the actual environment, the predicted sound pressure levels may not match the measured values.

5. CONCLUSIONS

This study compared the noise pressure level inside the cabin of a tilt-rotor aircraft obtained by a Statistical Energy Analysis (SEA) model with the results of Acoustic Transfer Path Analysis (ATPA), and the measured values with microphones in operation conditions. Using the SEA method for analysing a complex structure such as an aircraft is a relatively fast method to predict the acoustic behaviour of a system, especially compared to more detailed modelling methods such as finite element analysis. Also, it can be a cost-effective alternative to experimental testing.

In the SEA model, we used the mode shapes of a limited frequency range (900 Hz - 1250 Hz) to obtain the sound pressure level at high frequencies using the extrapolation method of the Actran software. At high frequencies, this module calculates interior sound pressure levels quicker than utilizing precise mode shapes. This is because the modal density at higher frequencies rises and leads to an increase in computation time.

The study results indicate that the sound pressure level calculated by the ATPA aligns with the sound pressure level captured by the microphones. On the other hand, the output of the SEA model was compared with the structure-borne noise synthesized by ATPA. It is shown both

methods follow the same trend, and at high frequencies, the SEA predicts the interior sound more accurately.

6. ACKNOWLEDGMENTS

The authors would like to extend their gratitude to Leonardo company for providing access to the tilt-rotor aircraft prototype for the measurements and their invaluable collaboration throughout this project. We would also like to express our sincere gratitude to Clean Sky 2 research program for the financial support of this project. Additionally, we thank the support team of ACTRAN for their invaluable assistance and guidance during the modelling process of this project.

7. REFERENCES

- [1] M. Bouhaj, O. Von Estorff, and A. Peiffer, "An approach for the assessment of the statistical aspects of the SEA coupling loss factors and the vibrational energy transmission in complex aircraft structures: Experimental investigation and methods benchmark," *J Sound Vib*, vol. 403, pp. 152–172, 2017.
- [2] J. Lin, "Airplane interior noise modeling using statistical energy analysis approach," in *5th AIAA/CEAS Aeroacoustics Conference and Exhibit*, 1999, p. 1903.
- [3] R. H. Lyon, R. G. DeJong, and M. Heckl, "Theory and application of statistical energy analysis." *Acoustical Society of America*, 1995.
- [4] A. Le Bot, *Foundation of statistical energy analysis in vibroacoustics*. OUP Oxford, 2015.
- [5] A. M. R. Ribeiro, J. M. M. Silva, and N. M. M. Maia, "On the generalisation of the transmissibility concept," *Mech Syst Signal Process*, vol. 14, no. 1, pp. 29–35, 2000.
- [6] N. M. M. Maia, J. M. M. Silva, and A. M. R. Ribeiro, "The transmissibility concept in multi-degree-of-freedom systems," *Mech Syst Signal Process*, vol. 15, no. 1, pp. 129–137, 2001.
- [7] O. Guasch, C. García, J. Jové, and P. Artís, "Experimental validation of the direct transmissibility approach to classical transfer path analysis on a mechanical setup," *Mech Syst Signal Process*, vol. 37, no. 1–2, pp. 353–369, 2013.
- [8] M. V van der Seijs, D. de Klerk, and D. J. Rixen, "General framework for transfer path analysis: History, theory and classification of techniques," *Mech Syst Signal Process*, vol. 68, pp. 217–244, 2016.
- [9] F. X. Magrans, "Method of measuring transmission paths," *J Sound Vib*, vol. 74, no. 3, pp. 321–330, 1981.



- [10] O. Guasch and F. X. Magrans, “The global transfer direct transfer method applied to a finite simply supported elastic beam,” *J Sound Vib*, vol. 276, no. 1–2, pp. 335–359, 2004.
- [11] À. Aragonès, J. Poblet-Puig, K. Arcas, P. V. Rodríguez, F. X. Magrans, and A. Rodríguez-Ferran, “Experimental and numerical study of Advanced Transfer Path Analysis applied to a box prototype,” *Mech Syst Signal Process*, vol. 114, pp. 448–466, Jan. 2019, doi: 10.1016/j.ymsp.2018.05.030.
- [12] D. Binet and F. Van Herpe, “Numerical Predictions of the Vibro-Acoustic Transmission Through the Side Window Subjected to Aerodynamics Loads,” in *Flinovia—Flow Induced Noise and Vibration Issues and Aspects-III*, Springer, 2021, pp. 297–309.
- [13] M. W. F. Wernsen, M. V van der Seijs, and D. de Klerk, “An indicator sensor criterion for in-situ characterisation of source vibrations,” in *Sensors and Instrumentation, Volume 5: Proceedings of the 35th IMAC, A Conference and Exposition on Structural Dynamics 2017*, Springer, 2017, pp. 55–69.
- [14] J. Petřík, R. Fiedler, and P. Lepšík, “Loss factor estimation of the plywood materials,” *Vibroengineering Procedia*, vol. 7, pp. 42–47, 2016.

